

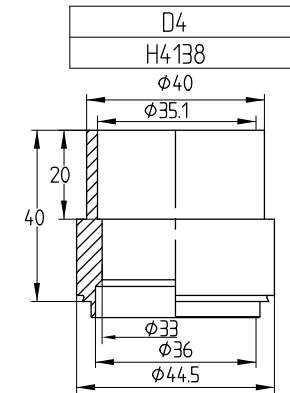

受控

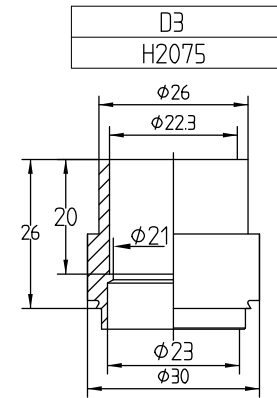
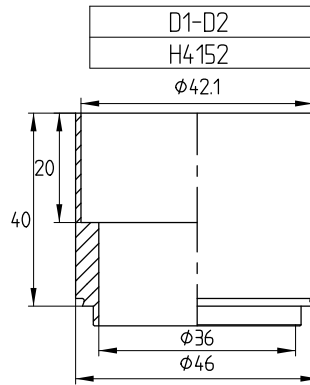
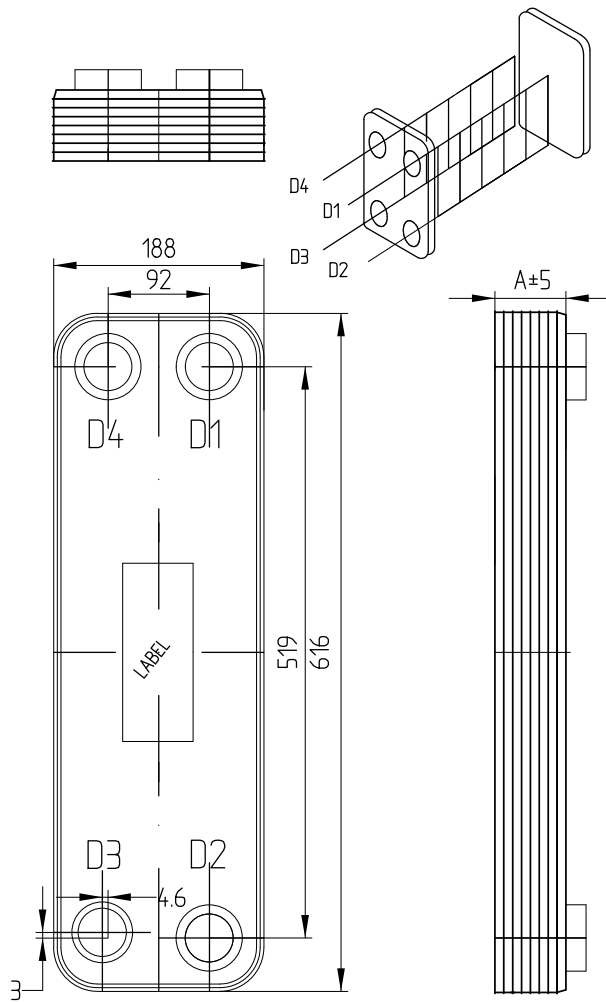

DESCRIPTION	A
BL95A-58(H4152-D1-D2,H2075-D3,H4138-D4)	148

		DESIGN DATA				
DESIGN PRESSURE		3.0MPa				
TEST PRESSURE		4.5MPa				
DESIGN TEMPERATURE		-196/+225				
LEAKAGE TEST		He检				
PLATE MATERIAL		316L				
PIPE MATERIAL		304				
FRAME MATERIAL		304				
Assembly drawing	DEPARTMENT	Sales Department	DATE	SCALE	 BAODE HEAT EXCHANGER 宝得换热	
	DESIGNER	JLN	2023/01/29			
	INSPECTOR	ZJF				MODEL
	APPROVAL	FL		DRAWING NO.		23010455

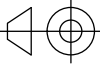
修改号	修改日期	修改内容	修改人员
-----	------	------	------